

ZWM 628IEH
ZWM 628WEH

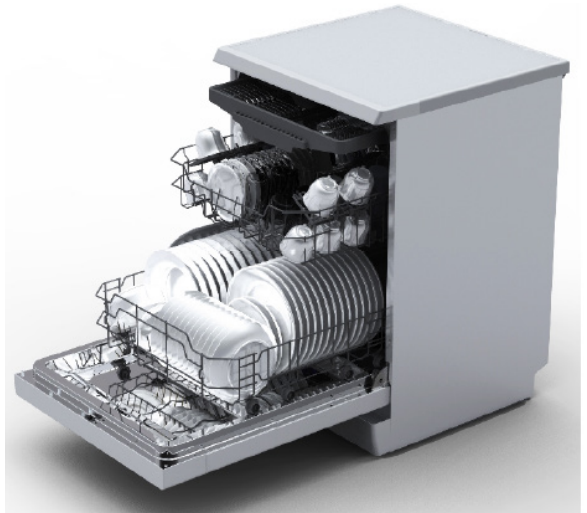

OPERATING INSTRUCTIONS

EN

DISHWASHER

Please carefully read these Operating Instructions before using the appliance!

THANK YOU FOR PURCHASING AN HANSA APPLIANCE

DEAR CUSTOMER,

Carefully read the operating instructions before plugging dishwasher to a power outlet and using the appliance. Operating instruction include tips that will help you avoid the risk of injury and damage to the appliance. Keep dishwasher documentation in a safe place for possible future use.

These operating instructions have been prepared for a range of appliances and some features described herein may not apply to your appliance.

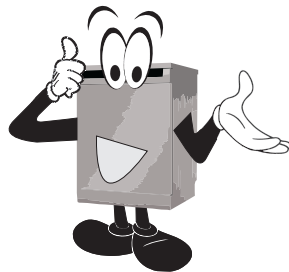

Symbols appearing in these instructions have the following meaning:



Important information concerning proper operation of the appliance and your personal safety.



Risks resulting from improper operation of the appliance. Activities that must be performed by a qualified technician.



Tips on how to use the appliance.



Information on how to protect the environment.



This indicates actions that must not be performed by the user.

CONTENTS

SAFETY INSTRUCTIONS FOR USE	3
CARE FOR THE ENVIRONMENT	6
INSTALL THE APPLIANCE	7
FEATURES AND COMPONENTS	9
PREPARE THE APPLIANCE FOR OPERATION	11
LOAD DISHES INTO DISHWASHER	16
TURN ON THE APPLIANCE AND SELECT PROGRAMME	19
TABLE OF PROGRAMMES	21
CLEANING AND MAINTENANCE	22
ERROR CODES AND TROUBLESHOOTING	23
PRACTICAL ADVICE AND USEFUL INFORMATION	24
PRODUCT FICHE	25



This appliance is intended exclusively for domestic use.
The manufacturer reserves the right to introduce changes, which do not affect operation of the appliance.

**Before you install the appliance**

Check the appliance for transport damage. Never install or use a damaged appliance. If in doubt, contact your seller.

**Before use**

- See installation notes (below).
- Refer the grounding system installation to a qualified electrician.
- The manufacturer shall not be liable for any damage arising from the use of a non-grounded appliance.
- Before using the appliance, verify that the data given on the rating plate matches that of local power outlets.
- Do not plug in the appliance before and during installation.
- Always use the original plug that came with the appliance.
- Do not use an extension cord to connect the appliance to the wall outlet. Extension cords are not sufficiently safe (e.g. they may overheat).
- Make sure the plug is easily accessible after installing the appliance.

- Do not use an extension cord to connect the appliance to the wall outlet. Extension cords are not sufficiently safe (e.g. they may overheat).
- Make sure the plug is easily accessible after installing the appliance.



This appliance can be used by children aged 8 years and older or persons with physical, mental or sensory handicaps, or those who are inexperienced or unfamiliar with the appliance, provided they are supervised or have been instructed how to safely use the appliance and are familiar with the associated risks. Ensure that children do not play with the appliance. Children should not be allowed to clean or maintain the appliance.

Children less than 3 years of age shall be kept away unless continuously supervised.

Child safety

- Do not allow children to play with the appliance.
- Dishwashing detergents can be caustic and irritate the eyes, mouth and throat. Read the safety notes from detergent manufacturer.
- Never leave children unsupervised when the appliance is open. It can contain residue detergent.
- Dishwasher water is not suitable for drinking. Danger of injury from the caustic chemicals.
- When you open the door during a programme, be careful as water temperature is high
- To avoid injury always place long and sharp/pointed items (e.g. forks, knives) in the cutlery basket, pointing down, or flat on the top basket.



Daily maintenance

- Use the appliance for household dishwashing only.
- Do not use solvents in the appliance as there is a risk of explosion.
- Do not sit or stand on the open door and do not place any objects on it. The device may overturn.
- Do not open the door when the appliance is operating. Hot water or steam can be released.
- Do not leave the door open, because they it can pose a hazard.



In case of problems

- Refer repair and modifications of the appliance to qualified technicians only.
- In the event of problems or repairs, unplug the appliance from the wall outlet:
- Unplug the appliance by pulling the plug,
- turn off the circuit breaker.
- Do not pull the power cord, pull the plug only. Close the water supply.



Recommendations

- To save energy and water, rinse food residue of the dishes before loading the dishes into the dishwasher. Run the dishwasher with full load.
- Use pre-wash programme only when needed.
- Load bowls, cups and mugs bottom facing up.
- Do not load in the appliance any dishes that are not dishwasher safe and do not load too many dishes.



Dishes and utensils that are not suitable for dishwashers.

- Ashtrays, candles, cleaning pastes, paints, chemicals, ferro-alloys;
- Forks, spoons and knives with a handle made of wood, ivory or Nacre, glued items, items contaminated with abrasive powders, acid or base

- Plastic dishes that are not resistant to high temperature, containers made of copper or tin;
- Aluminium and silver items (may be stained or loose lustre)
- Some delicate types of glass, porcelain with decorative prints, as prints may fade even after the first wash; some crystal dishes as they may lose their transparency, glued silverware sensitive to high temperatures, lead crystal glass, chopping boards, items made with synthetic fibres;
- Absorbent objects such as a sponge or kitchen cloths are not suitable for the dishwasher.



Before buying dishes in the future make sure they are dishwasher safe.



RECYCLING

Packaging and some parts of the appliance are made of materials suitable for recycling. They are marked with the recycling symbol and information about the type of material.

Before using the appliance remove all packaging and dispose of it in accordance with the regulations.



Warning!

The packaging can be dangerous for children. Recyclable materials can be taken to local waste collection. Additional information can be obtained from local authorities and at waste disposal points.



SCRAPPING OF AN OLD APPLIANCE



In accordance with European Directive **2012/19/EU** and Polish legislation regarding used electrical and electronic goods, this appliance is marked with the symbol of the crossed-out waste container.

At the end of its useful life, this product must not be disposed of with normal municipal waste. Instead, it should be taken to an electronic waste collection and recycling point. It is indicated by the symbol on the product itself, or on the Operating Instructions or packaging.

The materials used in making of this appliance can be reused, as indicated. By reusing or recycling the materials or parts, you will be playing an important part in protecting our environment. Information about the relevant disposal points for worn-out electrical goods is available from your local authorities.

Thank you for your contribution to environmental protection.

To avoid risks, prevent the appliance pending transport from being used.



Disconnect the plug and cut the power cord. Also damage the door lock.

INSTALL THE APPLIANCE

Placement of the product

- When choosing the place of installation, make sure you will be able to easily load and remove dishes and utensils from the dishwasher.
- Do not place the appliance in a room where the temperature can fall below 0°C.
- Before installing unpack the appliance following the instructions on the packaging.
- Place the appliance close to the water valve and drain. When installing the dishwasher assume that the connection will not be changed.
- When you move the appliance do not handle it by the door or control panel.
- Leave some room on all sides to have convenient access to the dishwasher when cleaning.
- Make sure that when you set the dishwasher you do not crush the water supply and drain hose. Also, make sure that the appliance is not placed on the power cord.
- Level the appliance using the adjustable legs. Proper level ensures trouble-free opening and closing the dishwasher doors.
- If the dishwasher door will not close properly, check that the appliance stands firmly on the floor, if not, adjust using the adjustable legs.

Water supply connection

Make sure that domestic water supply system is suitable for the dishwasher. It is recommended to install a filter in the water supply line to avoid damage to the appliance due to impurities (such as sand, clay, rust, etc.) that occasionally occur in water. This will also prevent accumulation of sediment after dishwashing.

Water supply hose

Do not use the water supply hose from the old dishwasher. Use the new water supply hose provided with the appliance. Before connecting, rinse the hose with water. Connect the water supply hose directly to the water feed valve. The domestic water system pressure should be at least 0.03 MPa and up to 1 MPa. If the water pressure exceeds 1 MPa, install pressure reducing valve.

When the connection is ready, open the valve completely and check for leaks.

For safety reasons, close the water supply tap after every wash.



NOTE: Aquastop water supply is used in some dishwasher models. Dangerous voltage could occur with Aquastop. Do not cut the Aquastop water supply. Do not allow it to bend or twist

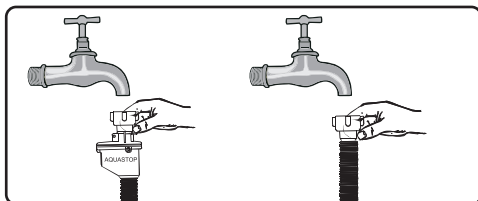

Important!
For safety reasons, close the water tap after every wash

The drain hose

The drain hose can be connected directly to a water drain or kitchen sink stub pipe. You can also drain the water directly into the sink using the special bracket (if available), placing the drain hose outlet on the kitchen sink edge. The drain hose connection should be made at least 50 cm and up to 110 cm from the floor.

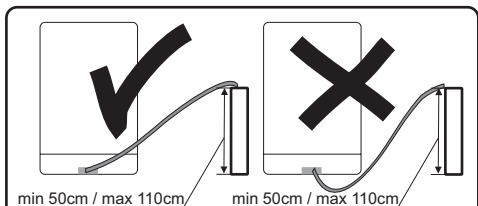

If the drain hose is longer than 4 m, dishes may not be washed properly. The manufacturer is not held responsible for such a situation

INSTALL THE APPLIANCE

Electrical connection

Grounded plug must be connected to a grounded power outlet with a proper voltage. If there is no grounding, refer this to a qualified electrician. If you operate the appliance without proper grounding, the manufacturer does not assume any liability for the possible resulting damage.



at lower voltage the dishwashing efficiency will deteriorate and may damage the appliance.

The power cord may only be replaced by authorized service or a qualified electrician. Failure to comply with these rules may lead to an accident.

For safety reasons, you should always unplug the appliance after you have finished using it.

In order not to avoid electric shock, do not remove the plug from the wall outlet with wet hands.

When you unplug the appliance from the wall outlet, always pull the plug. Never pull the power cord.



Domestic electrical system must be protected with a 10-16A fuse.

The appliance must be supplied with 220-240 V AC. If the supply voltage is 110 V, use 3000W, 110/220 V set-up transformer to connect the appliance. Do not connect the appliance during installation.

Always use the plug provided with the appliance. When you operate the appliance

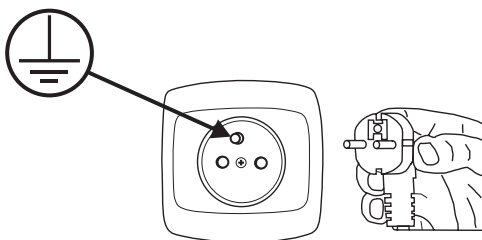

FEATURES AND COMPONENTS

The features and components of the appliance (fig. 1):

1. Spray arms
2. Cutlery rack
3. Upper basket
4. Inner pipe
5. Lower basket
6. Salt container
7. Dispenser
8. Cup shelf
9. Spray arms
10. Filter assembly
11. Inlet pipe connector
12. Drain pipe

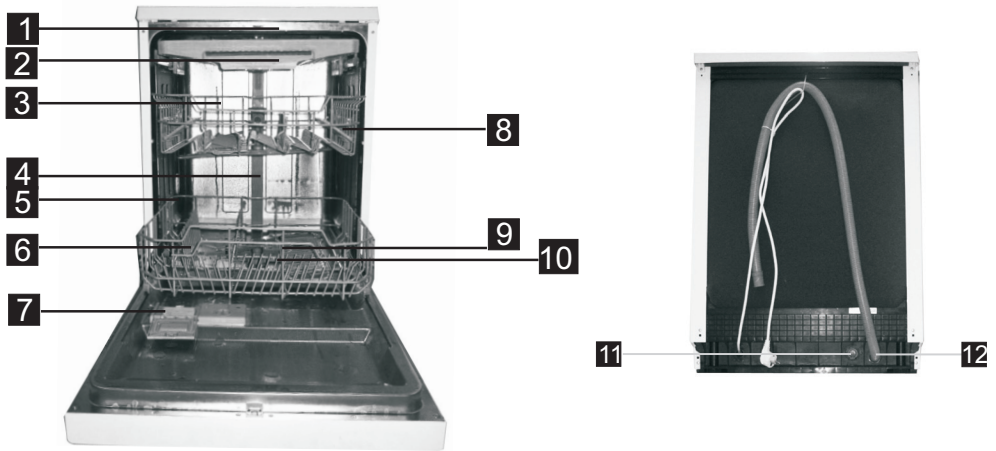

FEATURES AND COMPONENTS

Control panel (fig. 2):

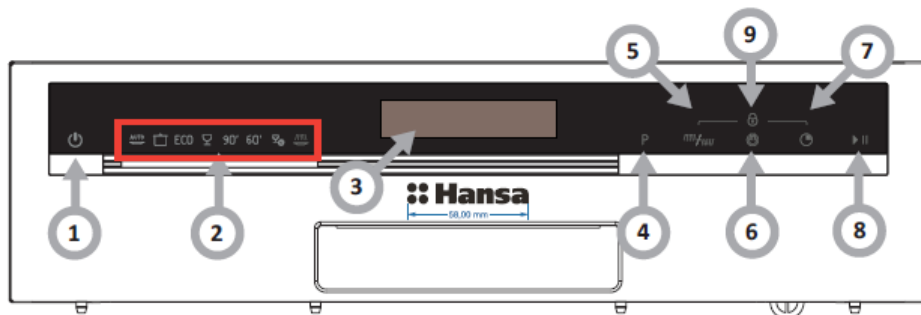

1. On/Off Button: to switch On/Off the appliance.
2. Program indicators: to show which program you have chose.
3. LED Display: to show the rinse aid, add salt, child lock, water faucet, 1/2, Extra drying etc.
4. Program Button: Press the button to select the program.
5. 1/2 button: Press the button to select 1/2 function.
6. Extra drying functions button: to select extra drying functions. (With this Extra drying function you can be used with Intensive, ECO, Glass, 90 min, 60 min).
7. Delay button: Press the button to chose the delay time.
8. Start /Pause button: to start the selected washing program or pause the washing program when the machine is working.
9. Child lock button: 1/2 button and delay button.

PREPARE THE APPLIANCE FOR OPERATION



Before first use

- Before using the appliance, verify that the data given on the rating plate matches that of local power outlets.
- Remove all packing materials from inside of the appliance.
- Prepare special salt (water softener).
- Add 2 kg special salt (intended for dishwashers) to the salt dispenser and fill it with water to the brim.
- Pour into the rinse aid dispenser.

(2) using the supplied funnel (2). Replace and close the lid. If the salt indicator on the control panel lights up, refill the special salt dispenser.

1

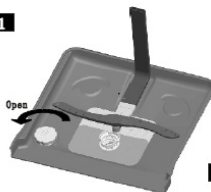

2

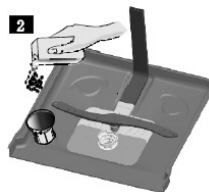

The importance of water descaling

A dishwasher requires soft water (with low calcium content) to operate efficiently. Otherwise, white residue main remain on the dishes and inside the appliance. This has a negative impact on the quality of dishwashing, rinsing and drying. When the water flows through the softener, ions responsible for the water hardness are removed, and the water becomes soft, for best dishwashing results. Depending on the degree of water hardness, the ions responsible for water hardness accumulate quickly inside the water softener. Therefore, the water softener must be regenerated to operate with the same efficiency during the next wash. This is why special salt is used in the dishwasher.



Use only the special salt intended for dishwashers.

Fill the salt container with water only before first use.

Do not add kitchen salt to the dishwasher. The salt dispenser can degrade over time. When you start a programme special salt dispenser is filled with water. Therefore, you should pour the special salt before starting the dishwasher.

Special salt will be washed away during the dishwashing programme. If you pour the special salt and do not intend to run a dishwashing programme, run the quick programme with an empty dishwasher in order to prevent corrosion.

Add special salt

Only use special salt intended for dishwashers. To add special salt you must first remove the lower basket and then open the lid of the salt dispenser by turning it counter clockwise - (1). Fill the special salt dispenser (~ 1.5 kg of special salt) and water



The test strip

The dishwashing effectiveness is linked to water hardness. Therefore, the appliance is equipped with a system to reduce the hardness of the water supply. The dishwashing effectiveness is improved when the system is set correctly. To check water hardness contact the municipal water company or determined the water hardness using test strip (if available).

Open the test strip package	Open the water tap for 1 min.	Immerse the test strip in the water for 1 second.	Once removed shake off the residual water	Wait 1 min.	Set the dishwasher water hardness in accordance with the measurement made Level 1 – no calcium Level 2 – very small calcium content Level 3 – small calcium content Level 4 – medium calcium content Level 5 – high calcium content Level 6 – very high calcium content
					Level 1 No Lime Level 2 Very low lime content Level 3 Low lime content Level 4 Medium lime content Level 5 Lime content Level 6 High lime content

PREPARE THE APPLIANCE FOR OPERATION

Fill the detergent dispenser

Press latch to open the detergent dispenser, as shown in figure. (1) The detergent dispenser features volume marking. Using these markings (lines) you can measure the correct amount of detergent. The dispenser can accommodate a maximum of 30g of detergent.

Open the pack with dishwasher detergent and in the case of heavily soiled dishes pour 25 cm³ detergent into the main wash compartment (b) or 15 cm³ for less soiled dishes. (2) If the dishes remained unwashed for an extended period of time or if food has dried, pour 5 cm³ detergent (a) into the pre-wash compartment and start the dishwasher. Depending on the amount of soil and the water hardness you may need to add more detergent.

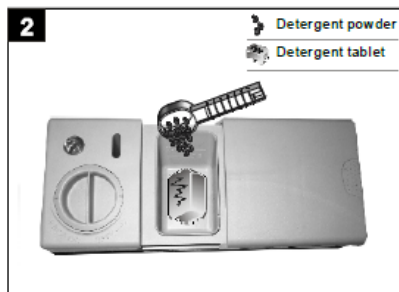
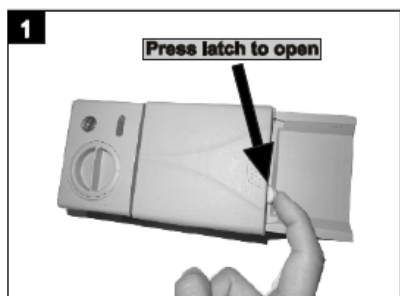

Multi-component (multitab) detergents (eg. 2-in-1, 3-in-1, etc.)

There are three types of detergents:

1. Containing phosphates and chlorine,
2. Containing phosphates and no chlorine,
3. Containing no phosphates and no chlorine.

The latest tablets are generally phosphate-free. Since phosphates have water softening properties, we recommend adding salt to the container even if the water hardness is only 6°dH. If you use phosphate-free detergent where water is hard, white residue may be visible on the dishes. You can prevent this by increasing the amount of detergent. Chlorine-free detergents have less bleaching effect. Stains may not be entirely removed. Select

the programme with a higher wash temperature.

Generally, using multi-component detergents suitable results are obtained only under certain conditions. Such detergents contain rinse aid and/or special salt in a specific amount. It is recommended to use special salt when using multi-component tablets.

What you should pay attention to when using these tablets.

- Always check the type of detergent used and whether it is a multi-component product.
- Make sure that the detergent used is appropriate for tap water hardness.
- Follow the instructions on the product packaging.
- If the detergent is in the form of tablets, never place it the cutlery basket. Always place the tablet in the detergent dispenser compartment.
- The use of these detergents yields good results only in certain applications. Using this type of detergent you should contact the manufacturer for information about proper use.
- If you use the detergent properly and dishwasher settings are correct you can save on salt and/or rinse aid.
- If dishwashing results while using 2-in-1 or 3-in-1 detergents are not satisfactory (traces of lime scale on the dishes), please contact the detergent manufacturer. The warranty does not cover complaints due to the use of multi-component detergents.



Recommended use: For best results using multi-component cleaning agents, add special salt and rinse aid in the dishwasher and set the water hardness and amount of rinse aid to the lowest setting.

The solubility of the detergent tablets made by different manufacturers can vary with regard to temperature and time. It is therefore not recommended to use detergent tablets in quick programmes. It is recommended to use powder detergents in quick programmes.



Always store detergents in a dry, cool place, out of reach of children. Add detergent to the dispenser immediately before using the appliance.

Warning: If encounter another problem when using a multi-component detergent, please contact the detergent manufacturer.

PREPARE THE APPLIANCE FOR OPERATION

Stop using multi-component detergents

- Add special salt and rinse aid to dispensers.
- Set the water hardness to the highest level (6) and run an empty dishwasher.
- Adjust the water hardness.
- Adjust rinse aid setting.

Add rinse aid to the dispenser and adjust setting

Use rinse aid to prevent the formation of white water drops, lime scale spots, white streaks that may occur on the dishes, as well as to improve the drying process. Contrary to popular belief, it not only serves to obtain a shiny dishes, but also to facilitate drying. For this reason, make sure there is always sufficient amount of rinse aid in the dispenser.

If the rinse aid indicator on the control panel lights up, add rinse aid to the dispenser.

To add rinse aid remove the dispenser lid by unscrewing it (1). Add rinse aid until the level indicator becomes dark. (4) Replace the lid and turn it until markings align. Use rinse aid level indicator to make sure the level is sufficient. Dark colour (4) indicates sufficient rinse aid level in the dispenser, and the light colour (4) indicates you need to add rinse aid to the dispenser.

You can adjust rinse aid dosage from 1 to 6. The factory setting for the rinse aid is 4. Adjust to a higher dose if streaks remain on the dishes after drying or to a lower dose if blue residue collets on the dishes.

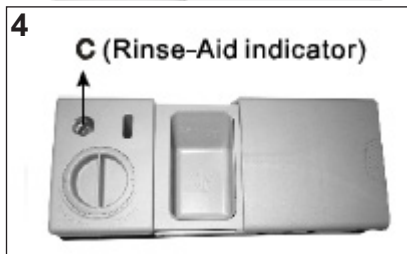
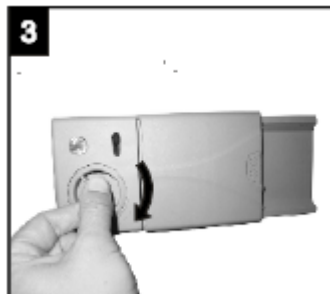
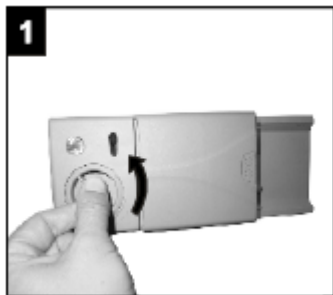

- Full
- $\frac{3}{4}$ full
- $\frac{1}{2}$ full
- $\frac{1}{4}$ full (add more)
- Empty



Warning: Use only rinse aid designed for domestic dishwashers. Wipe up spilled rinse aid with a cloth as it will cause the formation of large amounts of foam, and thus will reduce the dishwashing effectiveness.

PREPARE THE APPLIANCE FOR OPERATION

Close the Detergent compartment

If your dishes are only moderately dirty, you may be able to use less detergent than recommended.

-compartment

Press down the lid (1) until it clicks shut (2).

- if you are using detergent in tablet form, read the manufacturer recommendations on the packaging in order to determine where the tablets should be placed inside the dishwasher (e.g. in cutlery basket, detergent compartment, etc.). Make sure that the lid on the detergent compartment is closed, even if you are using tablets.



PREPARE THE APPLIANCE FOR OPERATION

Water hardness table

Water hardness	German degrees [dH]	French degrees [dF]	British degrees [dE]	Water hardness level indicator	Salt consumption [g/cycle]
1	0~5	0~9	0~6	H1	0
2	6-11	10-20	7-14	H2	9
3	12-17	21-30	15-21	H3	12
4	18-22	31-40	22-28	H4	20
5	23-34	41-60	29-42	H5	30
6	35-55	61-98	43-69	H6	60

If the water hardness is higher than the maximum values given in the table above, or if you use water from a deep well, it is recommended to use filters and water treatment equipment.

NOTE: The factory settings are for the water hardness level 3.

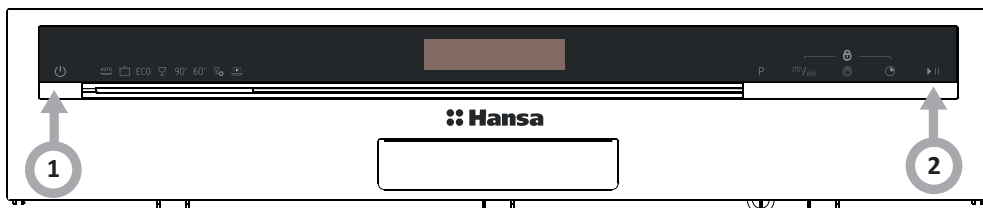

- 1 Switch on the appliance.
- ▶ || Press the Start/Pause button for more than 5 seconds to start the water softener set model within 60seconds after the appliance was switched on.
- ▶ || Press the button Start/Pause to select the proper set according to your local environment, the sets will change in the following sequence: H1->H2->H3->H4->H5->H6;
- 1 Press the On/Off button or no operation for 5 seconds to end the set up model.



The use of detergents

Use a detergent for domestic dishwashers. On the market you can find detergent intended for dishwashers in the form of powder, gel and tablets. The detergent must be placed in the dispenser before starting the dishwasher. Store detergent in a cool and dry place, out of reach of children. Do not overfill the detergent dispenser, otherwise the detergent may not dissolve completely and leave streaks on the dishes.

If you need more information on the detergent used, please contact the manufacturer directly.

LOAD DISHES INTO DISHWASHER

Upper basket

The upper basket is designed for washing delicate dishes such as glasses, cups, plates, etc. Dishes that are placed in the upper basket should be less soiled than dishes in the lower basket. In addition, you can place long forks, knives and spoons horizontally on shelves so as not to obstruct the spray arms.

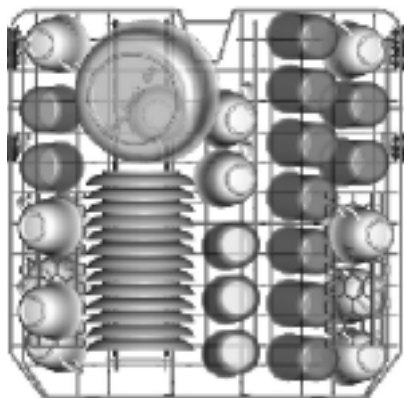

Fold the shelves

Fold the shelves to increase the capacity of the upper basket. You can place the glasses and mugs on the shelves.

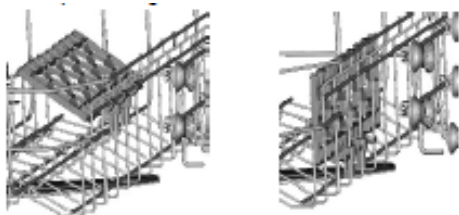

Adjust the height of upper basket

You can adjust the height of the upper basket to make more room for large dishes, both on the upper and lower basket. To adjust the height of the upper basket raise it to upper position and push the handle up to lower the lower basket — see figure below.

Raise the basket



Press the handle upward to lower the basket.



Adjust handle

Lower basket

Place the plates, bowls, pots, etc in the lower basket. Make sure that the dishes in the lower basket do not block spray arm and it can freely rotate. Place large pans and heavily soiled items such as pots, pans, lids, dishes, etc. in the lower basket. Place dishes upside down, so that water does not collect inside.



Place the dishes in such a way that they do not block the spray arm.

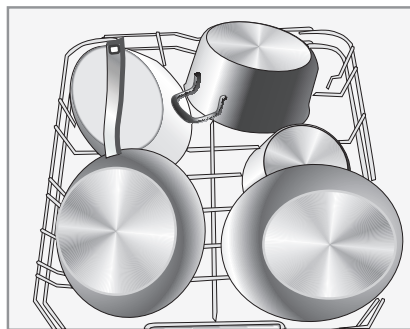

Fold lower basket elements

In order to make more room for pots and pan you can fold basket elements as shown in the figure.



LOAD DISHES INTO DISHWASHER

Cutlery basket

Place knives and forks separately from each other, and make sure they do not touch as this may cause poor washing results.

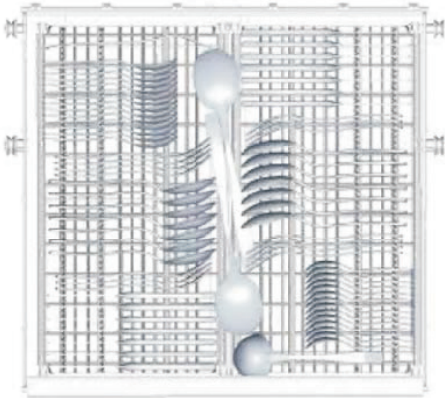

For best washing results place knives and forks in the cutlery basket, and make sure:

- Items do not touch
- Longest times are in the middle of the basket

⚠ Note: Cutlery must not project outside the cutlery basket outline

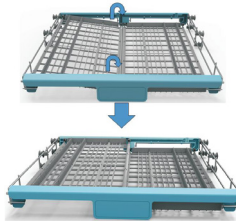

Position three: lift the right basket up, both left and right baskets are flat.

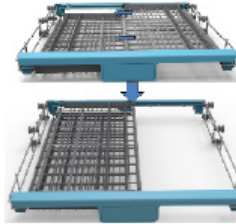

Position Four: Move the right basket from right to left, two basket are overlapping.

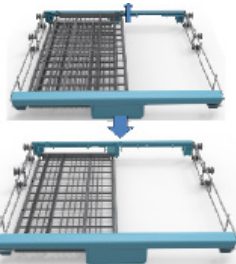

Position Five: Remove the right basket from the tray, only has the left basket.

Cutlery basket could be have 5 positions:



Position one: lift the left basket up, both left and right baskets are side lying.



Position two: adjust the left basket to lower position, left basket is flat and right basket is side lying.

LOAD DISHES INTO DISHWASHER

The standard load and test results

Capacity:

The upper and lower basket: 14 place settings. Set the upper basket to the upper position. Place the cups on the shelves.

Detergent/rinse aid

5+30g, in accordance with the EN 50242, IEC 436 international standards/rinse aid dose: 6

Test programme

Eco, in accordance with the EN 50242 international standard

Upper basket

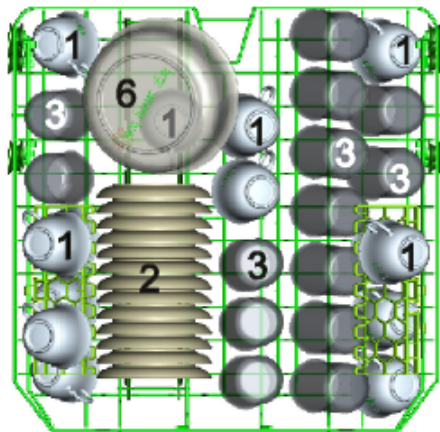

Lower basket

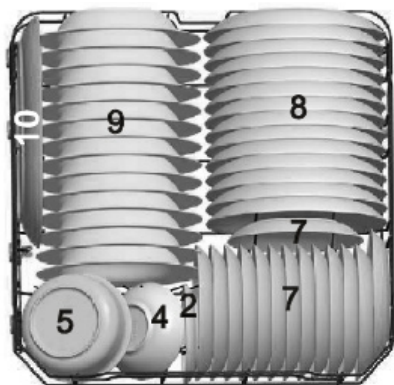

Cutlery basket

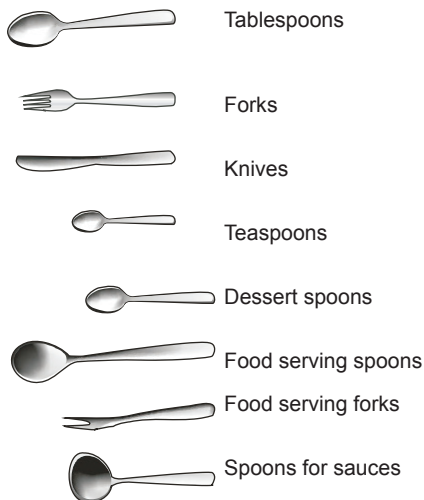
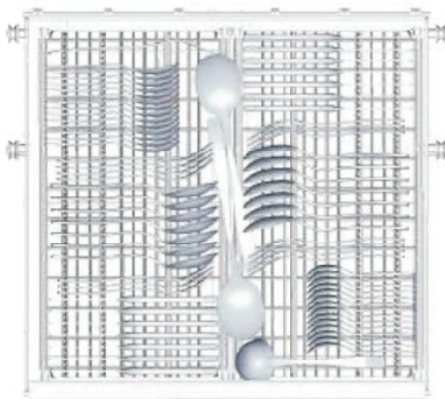

Tests specification according to EN 50242

Capacity — 14 standard place settings
 Upper basket setting — lower position
 Programme — ECO
 Rinse dose setting — 6
 Water hardness setting — H3

TURN ON THE APPLIANCE AND SELECT PROGRAMME

Turn on the appliance

P1	P2	P3	P4	P5	P6	P7	P8
45-55°C	65°C	40°C	45°C	90°	60°	60°	45°C

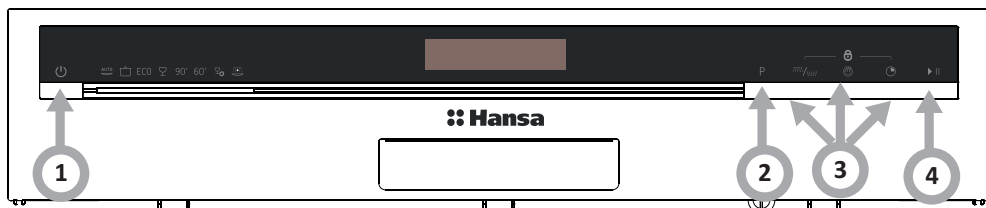

1. Draw out the lower and upper basket, load the dishes and push them back. It is commended to load the lower basket first, then the upper one (see the section entitled Loading the Dishwasher).
2. Pour in the detergent (see the section entitled Salt, Detergent and Rinse Aid).
3. Insert the plug into the socket. The power supply is 220-240 VAC /50 HZ, the specification of the socket is 10A 250VAC. Make sure that the water supply is turned on to full pressure.
4. Close the door, press the On/Off button, and the On/Off light will turn on.
5. Turn the programbutton , the wash programwill be changed as follows direction:
Auto->Intensive->ECO->Glass->90 min->60 min->Party->Soak;
If a programis selected, the response light will light. Then press the Start/Pause button, the dishwasher begins to start.

Adding dishes during the program:

1. You can add extra dishes at any time before detergent is released.
2. Press the Start/Pause button to pause the dishwashing programme.
3. Open the door gently.
4. You can open the door completely when spray arms come to a stop.
5. Add the dishes.
6. Close the door.
7. Press Start/Pause, and the dishwasher will resume programme after 10 seconds.

TURN ON THE APPLIANCE AND SELECT PROGRAMME

Change programme

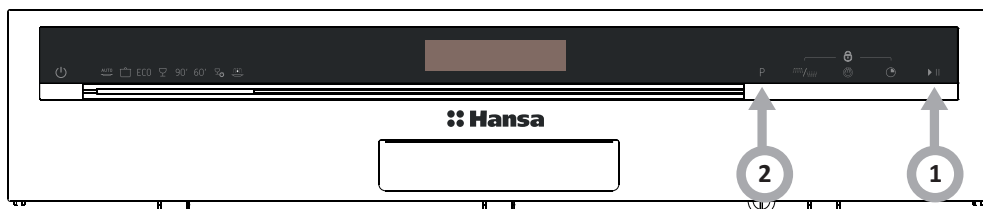

1. A cycle that is underway can only be modified if it has only been running for a short time. Otherwise, the detergent may have already been released, and the appliance may have already drained the wash water. If this is the case, the detergent dispenser must be refilled (see the section entitled "Loading the Detergent").

2. Press the Start/Pause button the machine will be in standby state, press the program button more than 3s then you can change the program to the desired cycle setting (see the section entitled "Starting a wash cycle. . .").



WARNING!

If you open the door during a wash cycle, the machine will pause. The program light will stop blinking and the buzzer will mooring every minute unless you close the door. After you close the door, the machine will keep on working after 10 seconds.

If your model has broken remember function, the machine will go on to finish the selected program after the power cut.

TABLE OF PROGRAMMES

Table*:

Programme name	Auto	Intensive	**ECO	Glass	90'	60'	Party	Soak
Temperature	45-55°C	60°C	45°C	40°C	65°C	60°C	40°C	-
Type of soil	Auto sensing wash, lightly, normally or heavily soiled crockery, with or without dried-on food	Heavily soiled dishes with dried food residue	Lightly soiled glass-ware and porcelain	Lightly soiled glass-ware and porcelain	Normally soiled dishes that require quick washing	Medium soiled dishes that require quick washing		To rinse dishes that you plan to wash later that day
Soil level	Different levels	Heavily soiled	Light soil	Light soil	Light soil	Light soil	Light soil	-
Amount of detergent	5g./30g (3 or 1 pieces)	5g./30g (3 or 1 pieces)	5g./30g (3 or 1 pieces)	5g./30g (3 or 1 pieces)	35g (3 or 1 pieces)	5/30g	-	-
	Pre-wash 45°C Autowash 45-55°C Rinse Rinse 65°C Dry	Pre-wash 60°C Wash 60°C Rinse Rinse Rinse 70°C Dry	Pre-wash Wash 45°C Rinse 60°C Dry	Pre-wash Wash 40°C Rinse Rinse 60°C Dry	Wash 65°C Rinse Rinse 65°C Dry	Pre-wash Wash 60°C Rinse 60°C Dry	Wash 40°C Rinse 45°C	Pre-wash
*Programme duration [min]	150	175	225	130	90	60	20	15
*Energy consumption [kWh]	0.9~1.3	1.6	0.93	0.9	1.35	1.15	0.45	0.02
*Water consumption [l]	11~15	17.5	10	13	12.5	10	7.2	4
*Rinse aid	★	★	★	★	★	★	-	-

Note: (★) means: Specify the rinse aid into a container with detergent.

** Standard programme This is a reference program for research institutes. Tests according to EN 50242.

This programme is suitable for washing normally soiled tableware. This is the most effective programme taking into account the total energy and water consumption for this kind of tableware.

* Programme duration, energy and water consumption value given in the table have been determined under laboratory conditions. The actual values can differ.

CLEANING AND MAINTENANCE

Regular dishwasher cleaning can extend its life-time of trouble-free operation.

Grease and limescale can accumulate in dishwasher chamber. In the event of such accumulation

- Add detergent and do not load any dishes. Select a high temperature washing programme and start the dishwasher. If the result is not satisfactory, use a special cleaner available on the market. (Cleaners manufactured specifically for dishwashers).

Clean the dishwasher door seal

To remove any accumulated residue from the door seals, wipe the seals regularly with a damp cloth.

Clean the dishwasher

Clean the spray arms and filters at least once a week. Before cleaning unplug the dishwasher from wall outlet and close the water supply valve. Do not use harsh or abrasive materials when cleaning. Wash with a mild cleaning agent and a damp cloth.

Filters

Check if food residue has accumulated on the strainer and fine filter. If so, remove the filters and clean them thoroughly under running water.

1. Main filter
2. Strainer
3. Fine filter

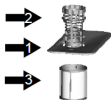

1. Remove the lower basket.
2. Turn the strainer counter-clockwise and pull it up.
3. Remove the filter assembly.
4. Remove the fine filter from the strainer
5. Thoroughly clean the filters under running water. Use a brush if necessary.
6. Install the filters in reverse order.
7. Insert the filter assembly into the chamber and then turn clockwise.

1



2

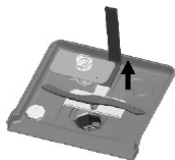

- Never use the dishwasher without the filter assembly.
- Improper mounting of the filters reduces the dishwashing effectiveness.
- Clean filters are key to correct dishwasher operation.

Cleaning the door lock

After each use wipe the door lock and around with a cloth soaked with mild detergent and wipe dry. Do not flood the lock with water. Do not use any aerosol cleaners. They may damage the lock and electric components inside.

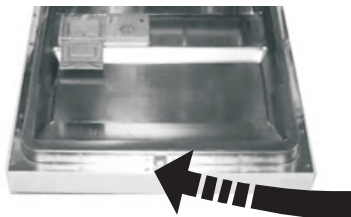

Spray arms

Make sure that jet nozzles the upper and lower spray arm are not clogged. If jet nozzles are clogged, remove the spray arms and clean them under running water.

Remove the lower spray arm by pulling it upwards, while the upper arm is removed by turning the nut counter-clockwise.

When mounting the spray arm make sure that the nut is well tighte

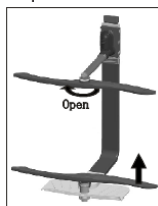

Water supply hose filter

The water is filtered by the filter in the water supply line to avoid damage to the appliance due to impurities (such as sand, clay, rust, etc.) that occasionally occur in water. This will also prevent accumulation of sediment after dishwashing. Periodically inspect the filter and hose and clean if necessary. To clear the filter, close the water supply valve, then remove the hose. Remove the filter from the hose and clean it under running water. Replace the clean filter inside the hose. Install the hose.

ERROR CODES AND TROUBLESHOOTING

Programme indicators:

- a) all indicators off — standby
- b) one programme indicator lights steady — programme paused pause or waiting to start the programme
- c) one indicator flashing — programme in progress, the appliance operates
- d) an indicator is flashing fast — error (see the following table)

ERROR CODE	DESCRIPTION OF THE FAULT	ACTION
E1	Longer inlet time.	• Faucets is not opened, or water intake is restricted, or water pressure is too low
E4	Overflow.	• Some element of dishwasher leaks
E8	Divider vale failed	• Divider vale failed

One of programme indicators lights up and the Start/Pause indicator flashes

- The dishwasher door is open — close the door.

If the programme won't start

- Make sure the plug is properly inserted into the wall outlet.
- Check the fuses in the electrical system
- Make sure that the water supply valve is open.
- Make sure that the door is closed.
- Make sure that the dishwasher is turned off by pressing the On/Off button.
- Make sure that the water supply filter and dishwasher filters are clean.

If the indicators do not go out after washing

- You did not press the On/Off button.
- If there is residue detergent in the dispenser
- Detergent was added to wet dispenser.

If there is water in the dishwasher when programme completes

- Water drain hose is clogged or kinked.

- The filters are clogged.
- The programme not yet completed.

The dishwasher stops during a washing programme

- Power failure.
- No water supply;
- The program can be paused.

You can hear clinking noises inside the appliance

- The dishes are arranged incorrectly.
- Spray arm hits the dishes.

If food residue remains on the dishes

- Dishes are improperly loaded into the dishwasher and the water does not reach everywhere.
- Basket overloaded.
- The dishes touch one another.
- A very small amount of detergent was added.
- Unsuitable, gentle washing programme selected.
- Spray arm clogged with food residue.
- Clogged filters.
- Filters improperly fitted.
- Drain pump clogged.

If white spots or streaks appear on the dishes

- Very small amount of detergent was added.
- Low dose of rinse aid.
- You are not using special salt, in spite of the

PRACTICAL ADVICE AND USEFUL INFORMATION

- high water hardness.
- Water softening system is at very low setting.
- The special salt dispenser lid is not closed properly.

If the dishes won't dry

- A program that does not include a drying phase has been selected.
- Special salt dosage set too low
- The dishes are removed too soon from the dishwasher.

If traces of corrosion appear on cookware

- The quality of cookware stainless steel is low.
- A lot of salt in the rinse water.
- The special salt dispenser lid is not closed properly.
- Too much special salt spilled when filling the

dispenser.

- The appliance is improperly grounded.

If the problem could not be corrected or, in the case of a defect not described above, please contact our service centre.

Manufacturer's Declaration

The manufacturer hereby declares that this product meets the requirements of the following European directives:

- Low Voltage Directive 2014/35/UE,
- Electromagnetic Compatibility (EMC) Directive 2014/30/UE,
- Eco-design Directive 2009/125/EC,

and has been marked with the **CE** symbol and issued with a declaration of compliance made available to market regulators.

PRODUCT FICHE

Product fiche in accordance with the Commission Delegated Regulation(EU) No 1059/2010 and in accordance with Commission Regulation (EU) No 1016/2010.

Supplier's name or trade mark	Hansa
Type	ZWM 628WEH / ZWM 628IEH
Rated capacity	14
Energy efficiency class ¹⁾	A++
Annual energy consumption in kWh (AEC) (280 cycles) ²⁾	266
Energy consumption of the standard cleaning cycle (Et) (kWh per cycle)	0,93
Power consumption in off-mode Po [W]	0,50
Power consumption in left-on mode (Pi) [W]	0,50
Annual water consumption in litres (AWC) (280 cycles) ³⁾	2800
Drying efficiency class (I _D) ⁴⁾	A
Standard programme ⁵⁾	Eco
The standard cleaning cycle duration [min]	225
Duration of the left-on mode (T _l) [min]	-
Sound pressure level [dB(A) re 1 pW]	45
Equipment designed for fitting	-
Height [mm]	845
Height (without worktop) [mm]	815
Width [mm]	598
Depth [mm]	600
Voltage/frequency	230 V / ~ 50 Hz / 10A
Water supply pressure	0.4-10 bar = 0.04-1 Mpa
Total power consumption [W]	1930
Heating element power [W]	1800
Washing pump power [W]	65
Drain pump power [W]	30
Cut-off device [A]	10
Net weight [kg]	50

¹⁾ A+++ (highest efficiency) to D (lowest efficiency)

²⁾ Energy consumption »X« kWh per annum based on 280 standard cleaning cycles using cold water and energy consumption in power saving modes. Actual energy consumption will depend on how the appliance is used.

³⁾ Water consumption »X« litres per year, based on 280 standard cleaning cycles. Actual water consumption will depend on how the appliance is used.

⁴⁾ Energy efficiency class »X« on a scale from G (lowest efficiency) to A (highest efficiency).

⁵⁾ This programme is suitable for washing normally soiled tableware. This is the most effective programme taking into account the total energy and water consumption for this kind of tableware.

The appliance meets the European standards and requirements of the directives in the current version at delivery:

- LVD 2014/35/UE

- EMC2014/30/UE

- EUP 2009/125/EC

The above values have been measured in accordance with standards under specified operating conditions.

Results may vary greatly according to quantity, water hardness, amount of detergent and the level of tableware soil, etc. The manual is based on the European Union's standards and rules.

We reserve the right to make design and technical changes to the appliance.





