

Dear Customer,

This Quick Start Guide is enclosed with detailed dishwasher Operating Instructions. Before using the appliance carefully read the Operating Instructions, especially guidelines for safe use.

Before plugging your dishwasher into the mains power, remove the safety packaging. Do not start the dishwasher before it is properly set up.

1 Turn on the appliance

- Open the dishwasher door, press the on/off button. Power indicator will be on

2 Dispense detergent

- Press the latch to open the detergent dispenser.
- Add detergent to the dispenser.

3 Check the special salt level

- Add special salt to the dispenser when the corresponding indicator on the control panel comes on.

4 Load the dishes

- Remove food leftovers from the dishes
- Place the dishes in the baskets according to loading guidelines.
- It is recommended to load the lower basket first, then the upper basket.

5 Select the wash programme

- Open the door, press the Power button. Choose a program, the response light will turn on.
- Then close the door, the dishwasher will start its cycle.

6 Start your dishwasher

- Open the dishwasher door.
- The dishwasher will start a wash programme.

7 Turn off the appliance

- Turn the appliance off using the On/Off button.

8 Remove dishes from the appliance

- When the dishwasher is off, open the door and wait about 15 minutes before removing the dishes. This will also facilitate the drying process. Hot dishes are more susceptible to cracking.

9 Features and components

- Spray arms
- Cutlery basket
- Upper basket
- Inner tube
- Lower basket
- Salt container
- Detergent dispenser
- Mugs and cups shelves
- Main filter
- Water supply hose connection
- Water drain hose
- Regulator

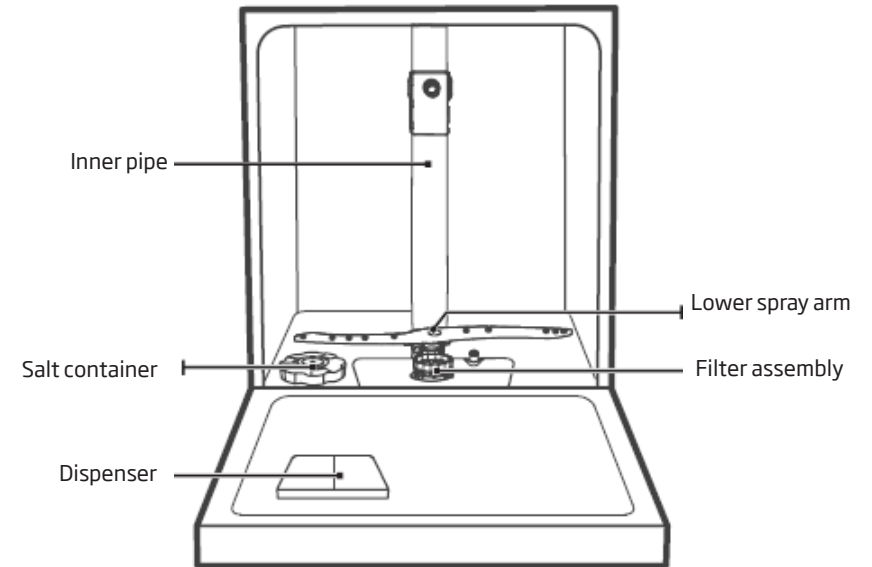

Cutlery basket

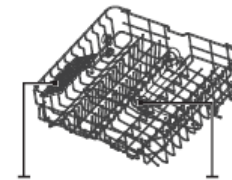

Cup rack

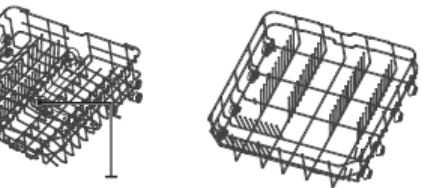

Upper spray arm

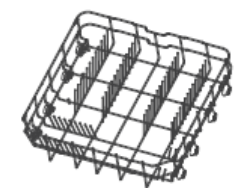







Lower basket

Upper basket



NOTE: Figures are for illustrative purposes only Individual models may vary.

TABLE OF WASH PROGRAMMES: EGSPV 596 910 / ZIM656PB

ITEM	Programme name	The default temperature [°C]	Type of soil	Soil level	Amount of detergent	Type of cycle						Duration [min.] *	Power consumption [kWh] *	Water consumption [litres] *
1	Hygiene 	70°	With the Sanitize option selected, the water temperature is increased to 70 °C for high temperature sanitization.	Intensive soil	5g / 25g (1 or 2 items)	Pre-wash 50°C	Wash 70°C	Rinse	Rinse	Rinse 70°C	Dry	200	1.772	19.0
2	1 hour 	55°	For normally soiled loads that need quick wash.	Light soil	30g (1 item)	Wash 55°C	Rinse	Rinse 50°C	Dry			60	0.853	11.4
3	**ECO 	50°	Lightly soiled glass-ware and porcelain	Light soil	30g (1 item)	Wash 50°C	Rinse	Rinse 45°C	Dry			210	0.808	11.0
4	Self-Cleaning 	70°	This program provides an effective cleaning of the dishwasher itself.	Light soil	5g / 25g (1 or 2 items)	Pre-wash 45°C	Wash 70°C	Rinse	Rinse 70°C	Dry		145	1.241	14.9
5	Glass 	50°	For lightly soiled crockery and glass.	Light soil	5g / 25g (1 or 2 items)	Pre-wash 40°C	Wash 50°C	Rinse 50°C	Dry			120	0.902	15.0
6	Rapid 	40°	A shorter wash for lightly soiled loads that do not need drying.	Light soil	15g (1 item)	Wash 40°C	Rinse 40°C	Rinse 55°C				30	0.781	11.0

** Standard programme This is a reference program for research institutes. Tests according to EN 50242. This programme is suitable for washing normally soiled tableware. This is the most effective programme taking into account the total energy and water consumption for this kind of tableware.

* Programme duration, energy and water consumption value given in the table have been determined under laboratory conditions. Actual values can vary.

Dear Customer,

This Quick Start Guide is enclosed with detailed dishwasher Operating Instructions. Before using the appliance carefully read the Operating Instructions, especially guidelines for safe use.

Before plugging your dishwasher into the mains power, remove the safety packaging. Do not start the dishwasher before it is properly set up.

1 Turn on the appliance

- Open the dishwasher door, press the on/off button. Power indicator will be on

2 Dispense detergent

- Press the latch to open the detergent dispenser.
- Add detergent to the dispenser.

3 Check the special salt level

- Add special salt to the dispenser when the corresponding indicator on the control panel comes on.

4 Load the dishes

- Remove food leftovers from the dishes
- Place the dishes in the baskets according to loading guidelines.
- It is recommended to load the lower basket first, then the upper basket.

5 Select the wash programme

- Open the door, press the Power button. Choose a program, the response light will turn on.
- Then close the door, the dishwasher will start its cycle.

6 Start your dishwasher

- Open the dishwasher door.
- The dishwasher will start a wash programme.

7 Turn off the appliance

- Turn the appliance off using the On/Off button.

8 Remove dishes from the appliance

- When the dishwasher is off, open the door and wait about 15 minutes before removing the dishes. This will also facilitate the drying process. Hot dishes are more susceptible to cracking.

9 Features and components

- Spray arms
- Cutlery basket
- Upper basket
- Inner tube
- Lower basket
- Salt container
- Detergent dispenser
- Mugs and cups shelves
- Main filter
- Water supply hose connection
- Water drain hose
- Regulator

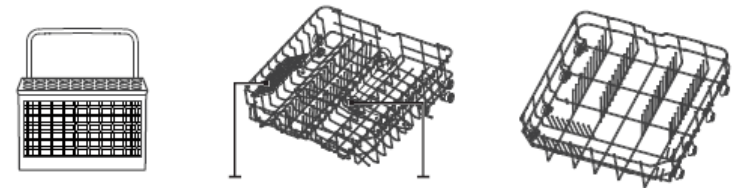
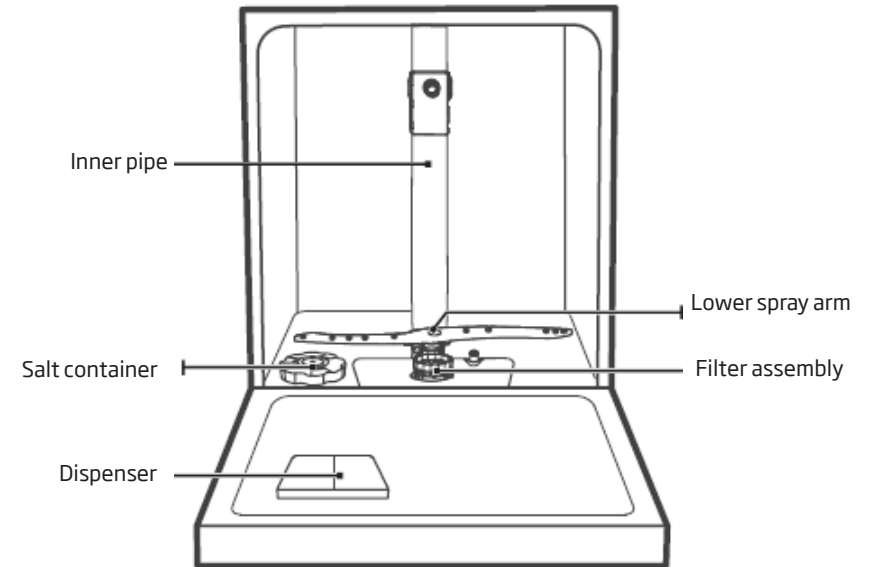

Cutlery basket

Cup rack

Upper spray arm







Lower basket

Upper basket



NOTE: Figures are for illustrative purposes only Individual models may vary.

TABLE OF WASH PROGRAMMES: EGSPV 596 910 / ZIM656PB

ITEM	Programme name	The default temperature [°C]	Type of soil	Soil level	Amount of detergent	Type of cycle						Duration [min.] *	Power consumption [kWh] *	Water consumption [litres] *
						Pre-wash	Wash	Rinse	Rinse	Rinse	Dry			
1	Hygiene 	70°	With the Sanitize option selected, the water temperature is increased to 70 °C for high temperature sanitization.	Intensive soil	4g / 16g (1 or 2 items)	Pre-wash 50°C	Wash 70°C	Rinse	Rinse	Rinse 70°C	Dry	200	1.772	19.0
2	1 hour 	55°	For normally soiled loads that need quick wash.	Light soil	20g (1 item)	Wash 55°C	Rinse	Rinse 50°C	Dry			60	0.853	11.4
3	**ECO 	50°	Lightly soiled glass-ware and porcelain	Light soil	20g (1 item)	Wash 50°C	Rinse	Rinse 45°C	Dry			210	0.824	11.0
4	Self-Cleaning 	70°	This program provides an effective cleaning of the dishwasher itself.	Light soil	4g / 16g (1 or 2 items)	Pre-wash 45°C	Wash 70°C	Rinse	Rinse 70°C	Dry		145	1.241	14.9
5	Glass 	50°	For lightly soiled crockery and glass.	Light soil	4g / 16g (1 or 2 items)	Pre-wash 40°C	Wash 50°C	Rinse 50°C	Dry			120	0.902	15.0
6	Rapid 	40°	A shorter wash for lightly soiled loads that do not need drying.	Light soil	12g (1 item)	Wash 40°C	Rinse 40°C	Rinse 55°C				30	0.781	11.0

** Standard programme This is a reference program for research institutes. Tests according to EN 60436. This programme is suitable for washing normally soiled tableware. This is the most effective programme taking into account the total energy and water consumption for this kind of tableware.

* Programme duration, energy and water consumption value given in the table have been determined under laboratory conditions. Actual values can vary.